

TYPE LR075H

Abmessungen

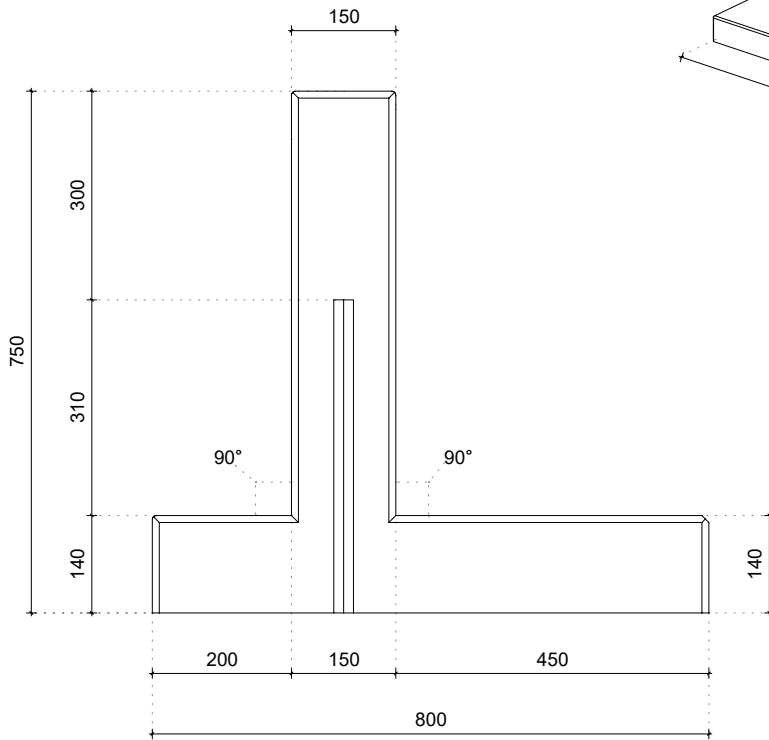

Details

Abgerundeter Obenseite

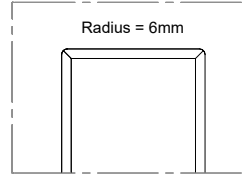

Nut für Koppelleiste

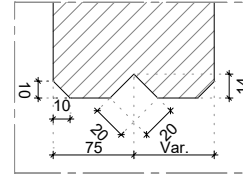

Anschluss der Elemente

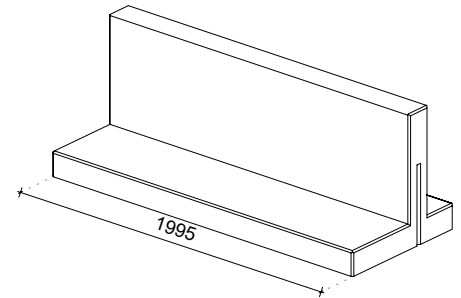
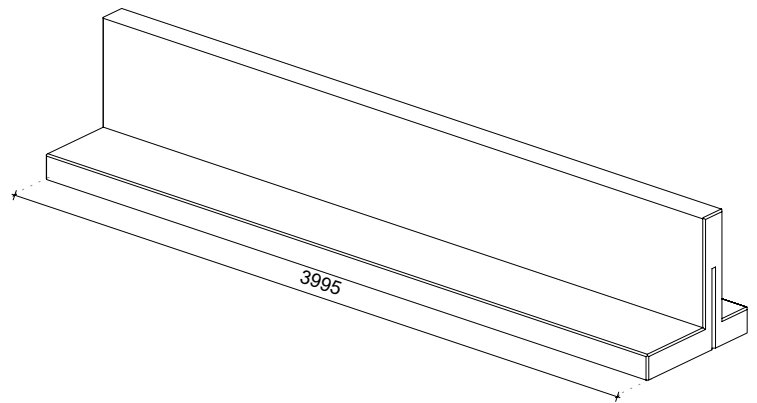
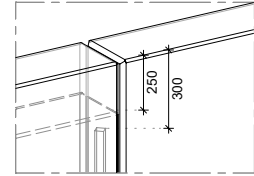

Technische details

Beton Rezeptur	2nd Generation self-compacting C60/75
Bewehrungsstahl	B500
Gewicht	1929kg (L = 3995mm) / 963kg (L = 1995mm)
Betondeckung	45mm
Maßtoleranz	+/- 5mm
Sichtbetonklasse	Beidseitig Sichtklasse SB2
Entwurfslebensdauer	100 Jahre
Produktgarantie	10 Jahre
Expositionsklassen	XA3, XC4, XD3, XS3, XF4, WF
Hebevorrichtung	Keine, Aufstellung mit Klammer

Konstruiert nach

DIN-EN 1990 Eurocode 0	DIN-EN 206
DIN-EN 1991 Eurocode 1	Inkl. nationale Anhänge
DIN-EN 1992 Eurocode 2	
DIN-EN 1997 Eurocode 7	

Produktionsweise



Energie
Neutral



Gefiltertes
Regenwasser



Nachhaltige
Rohstoffe



Recyclebare
Materialien

Zertifizierung

