

TYPE HOEKL075

Abmessungen

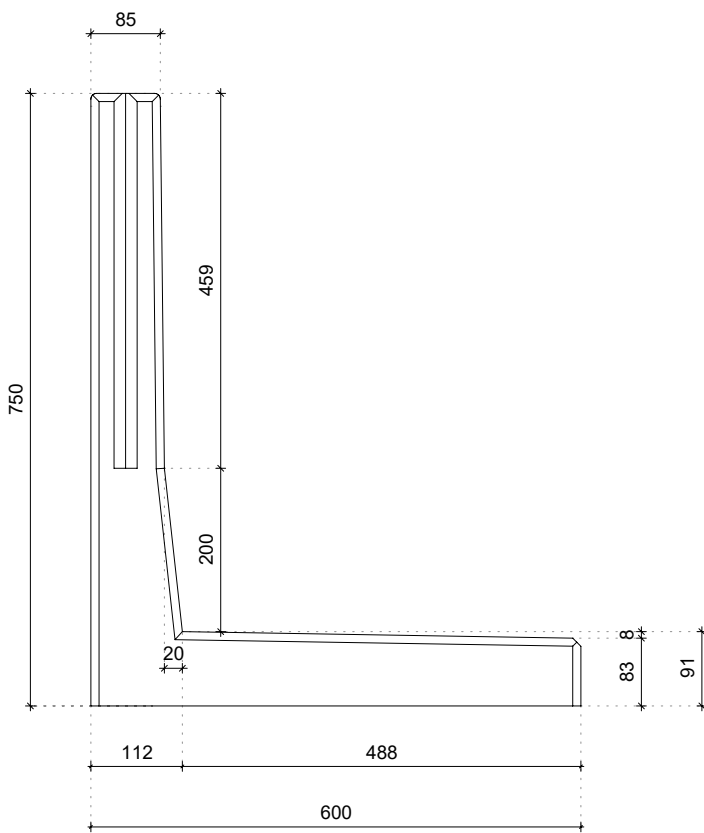

Details

Abgerundeter Obenseite

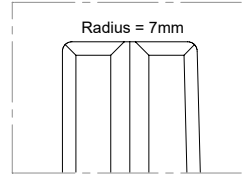

Nut für Koppelleiste

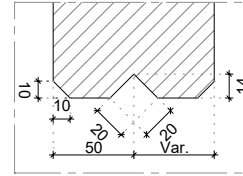

Anschluss der Elemente

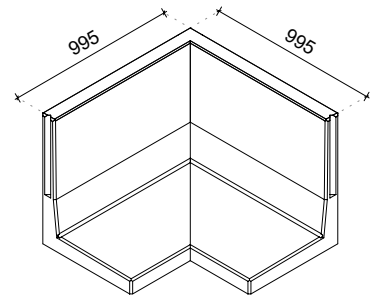
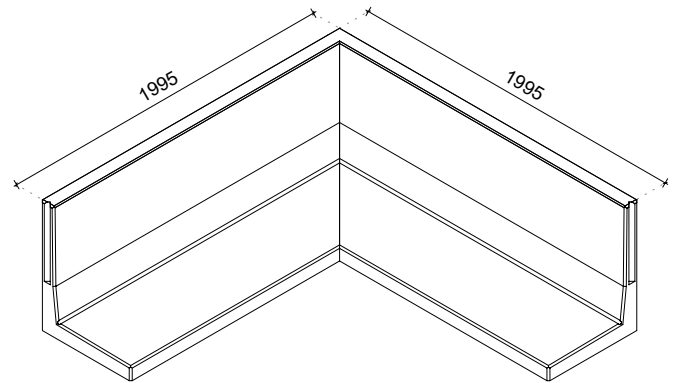
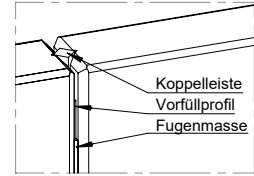

Technische details

Beton Rezeptur	3 rd generation self-compacting C55/67
Bewehrungsstahl	B500
Gewicht	980kg (L = 1995x1995mm) 450kg (L = 995x995mm)
Betondeckung	30mm
Maßtoleranz	+/- 5mm
Sichtbetonklasse	Beidseitig Sichtklasse SB2
Entwurfslebensdauer	50 Jahre
Produktgarantie	10 Jahre
Expositionsklassen	XA3, XC4, XS3, XF3, WF
Hebevorrichtung	Keine, Aufstellung mit Klammer

Konstruiert nach

DIN-EN 1990 Eurocode 0	DIN-EN 206
DIN-EN 1991 Eurocode 1	Inkl. nationale Anhänge
DIN-EN 1992 Eurocode 2	
DIN-EN 1997 Eurocode 7	

Produktionsweise



Energie
Neutral



Gefiltertes
Regenwasser



Nachhaltige
Rohstoffe



Recyclebare
Materialien

Zertifizierung

